

1

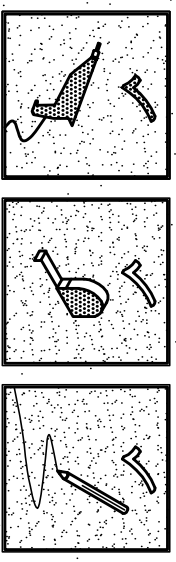

2

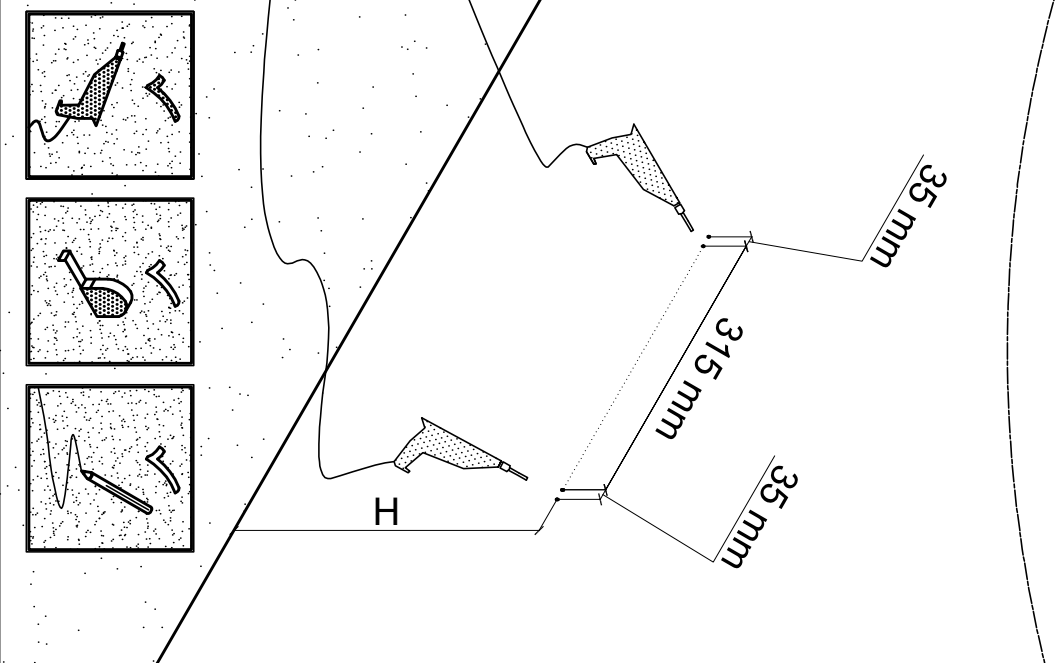
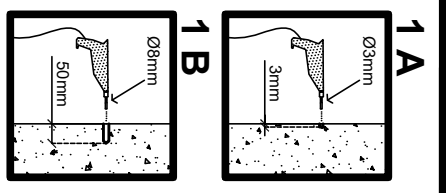
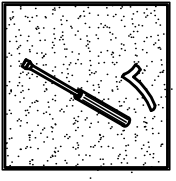
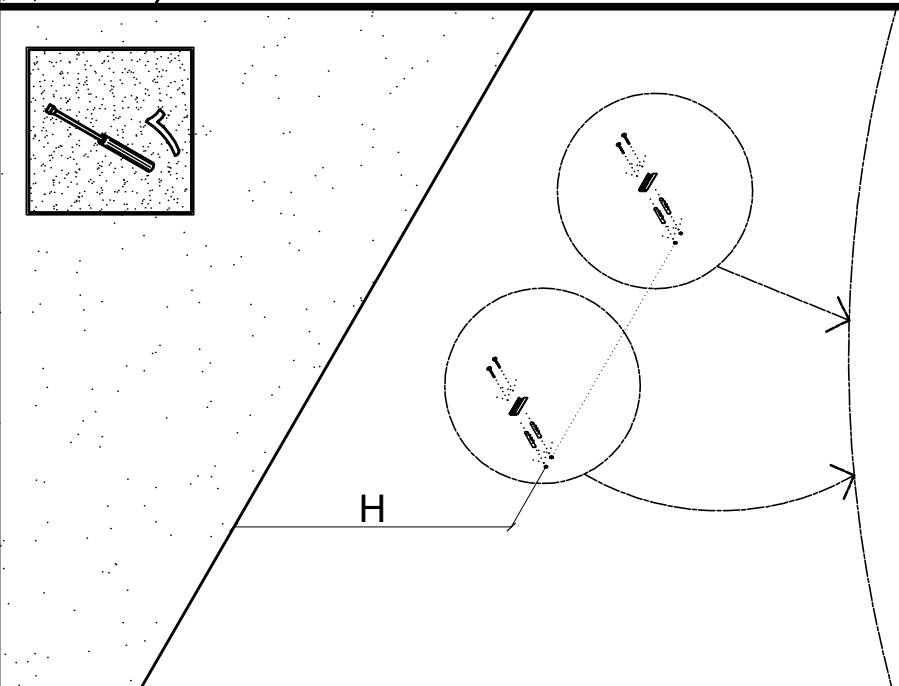
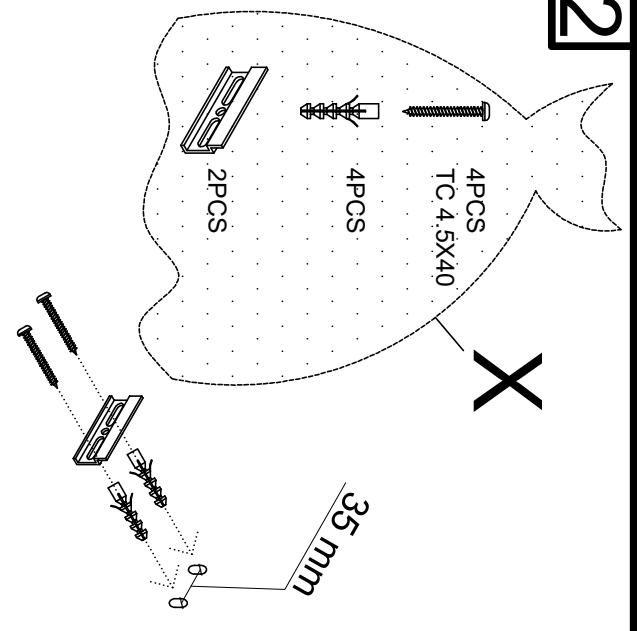

3

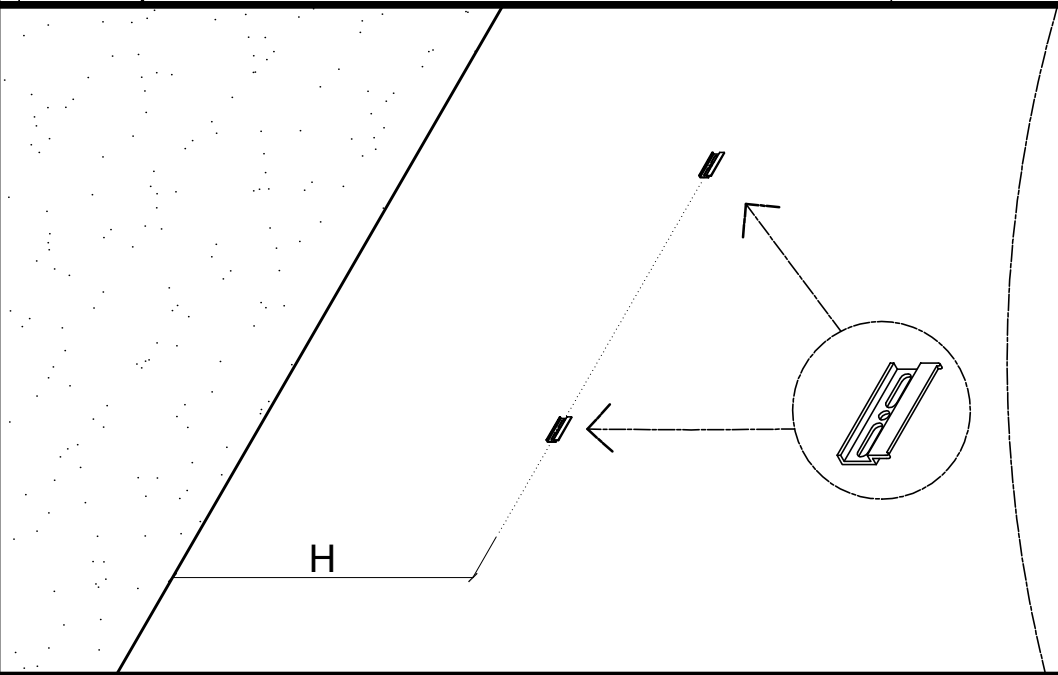
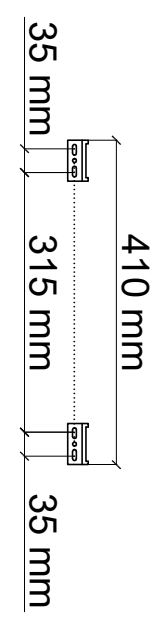

4

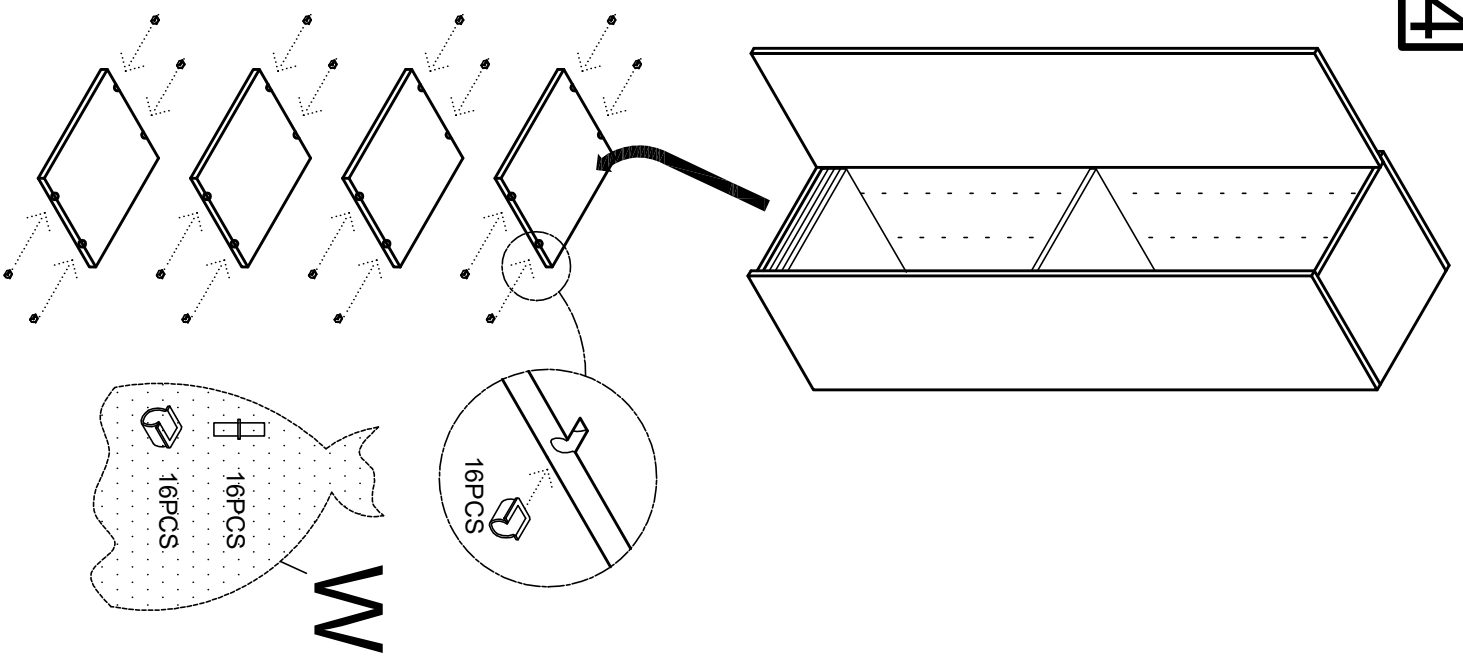

5

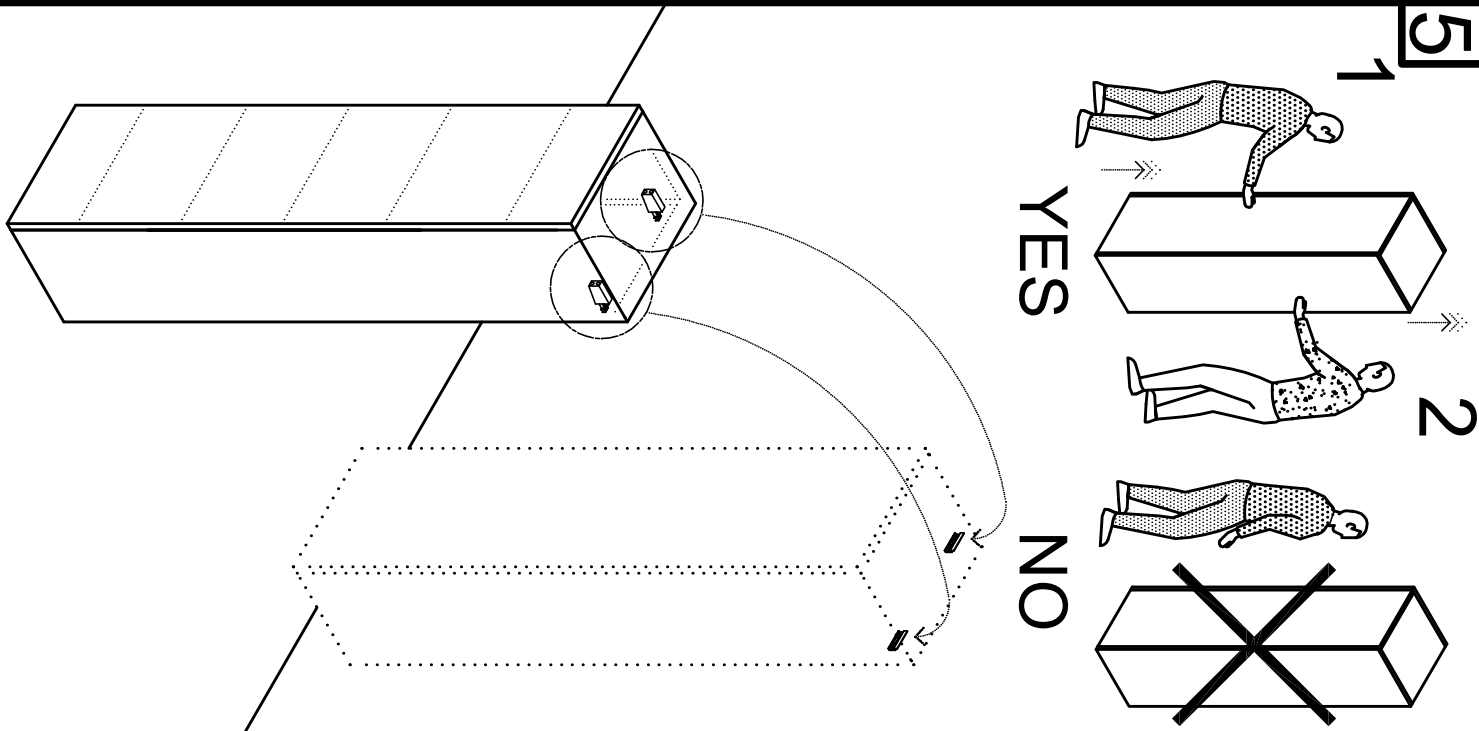

6

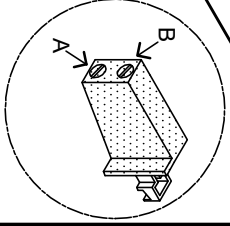
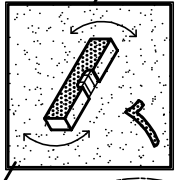
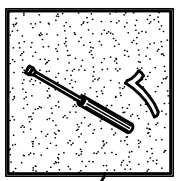
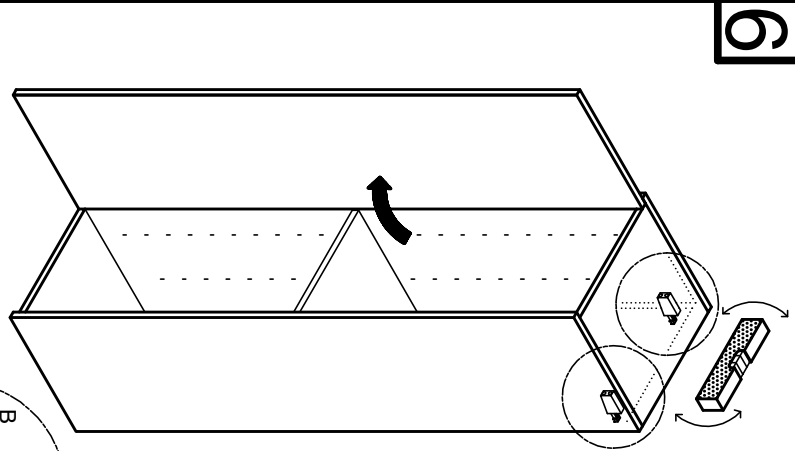

6A

6B

7

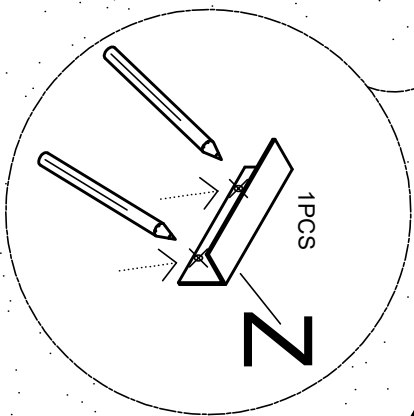
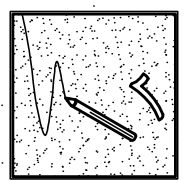
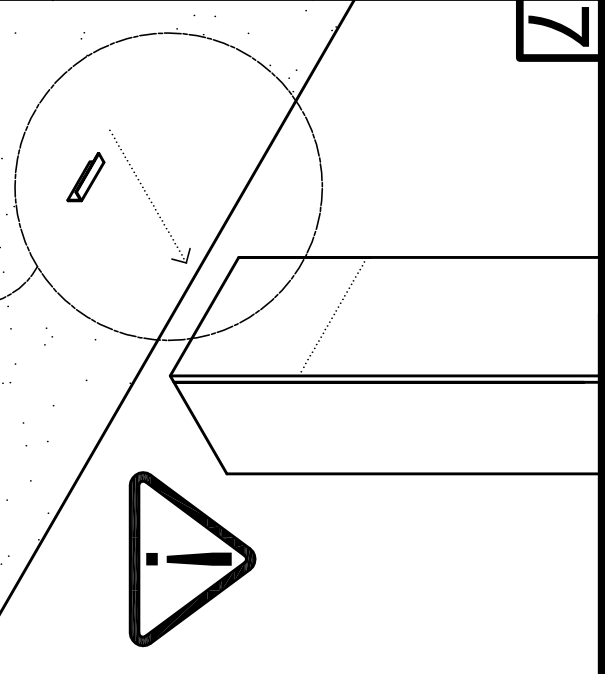

7A

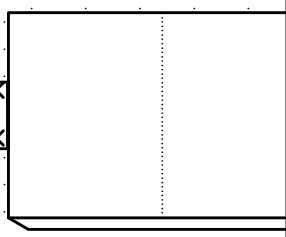

8

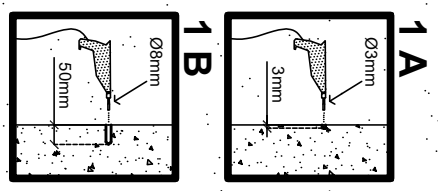
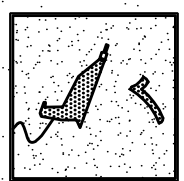
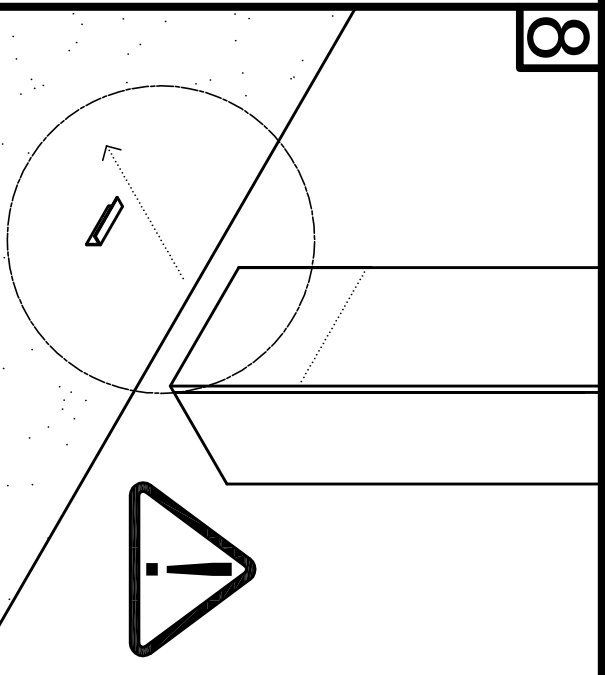

8A

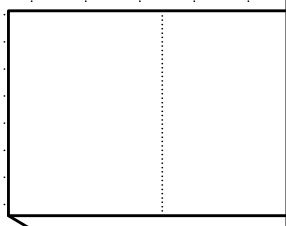

9

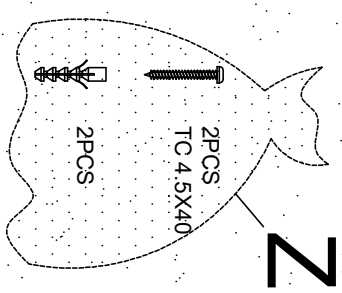
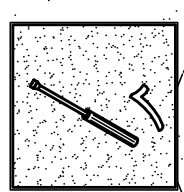
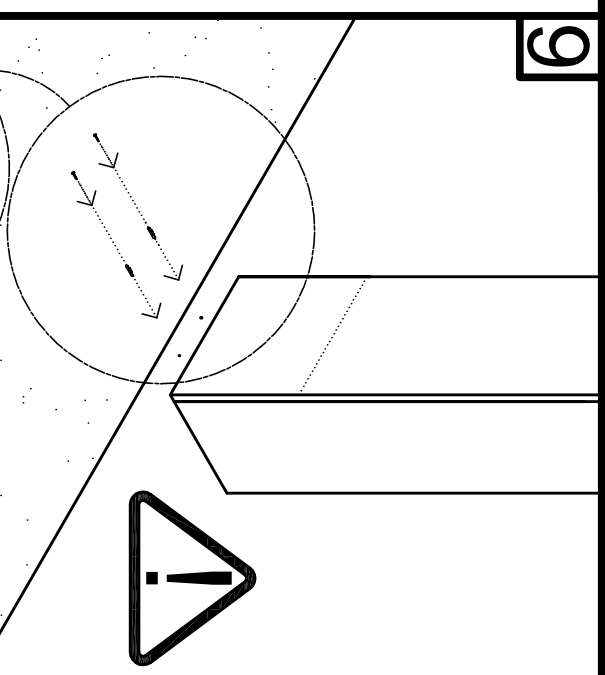

9A

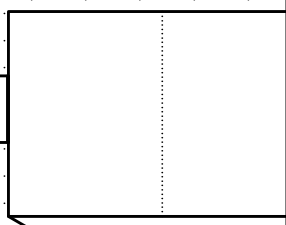

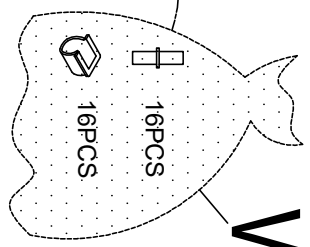
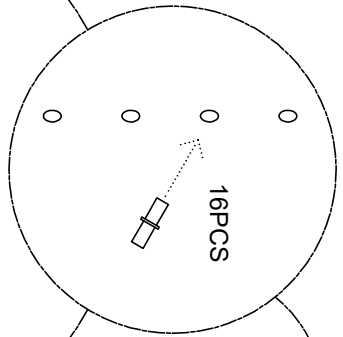
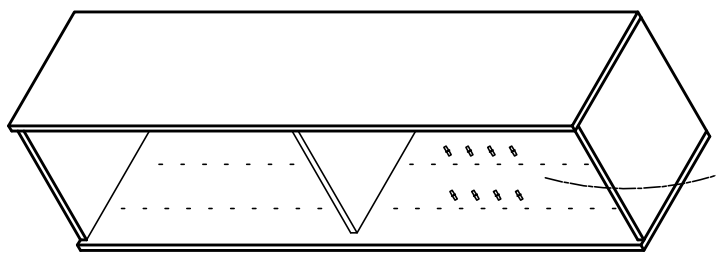
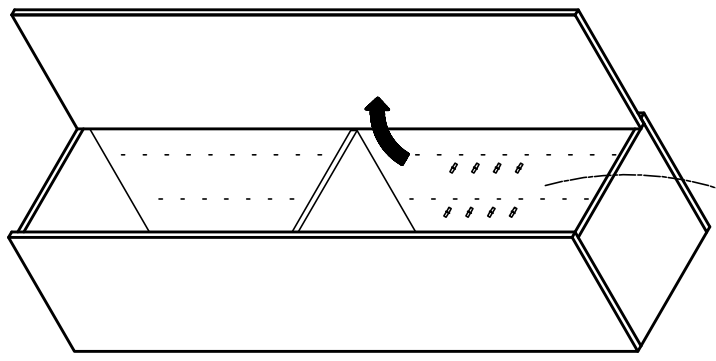

W

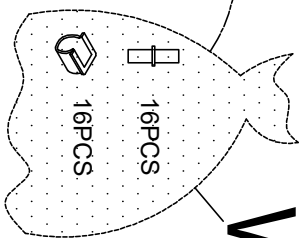
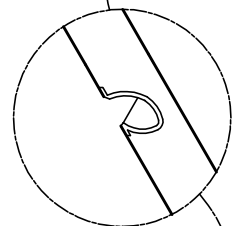
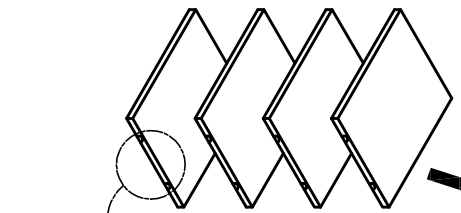
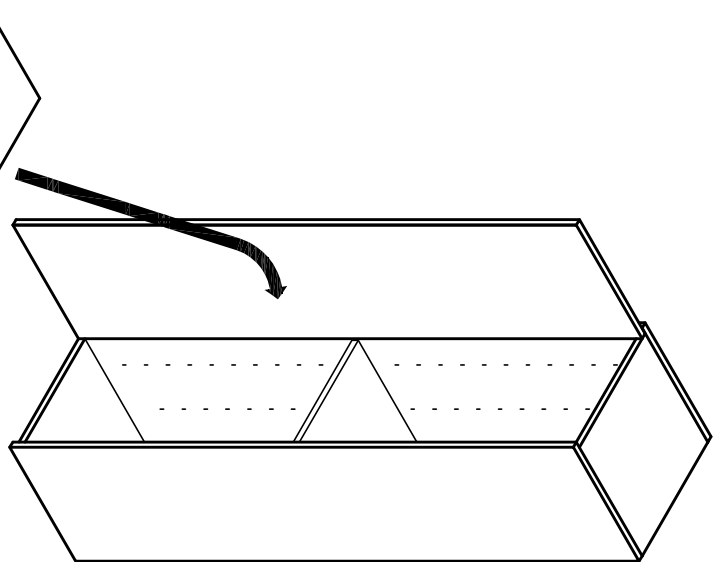

W

## **ACHTUNG!**

Zur Reinigung der Fronten und des Korpusen verwenden Sie bitte Wasser mit Seife, einen Glasreiniger oder Alkohol

## **WARNING!**

To clean front surface and structure please use water and soap, glass cleaner or alcohol

## **ОСТОРОЖНО!**

Чтобы очистить фасады и структуры мебели, используйте мыло и воду или продукт для очистки стёкол или алкоголь

## **ATTENTION!**

Pour nettoyer les façades et la structure, utilisez de l'eau avec du savon, un nettoyant pour vitres ou de l'alcool.

## **HUOMIO!**

Ovien ja rungon puhdistukseen voidaan käyttää mieto saippualliuosta tai lasin puhdistukseen tarkoitettua nestettä.

## **ATTENZIONE!**

Per pulire le superfici del mobile, utilizzare acqua e sapone, o soluzione per vetri oppure alcool